

(A) x1

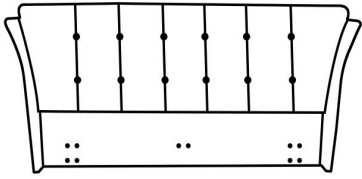

(B) x1

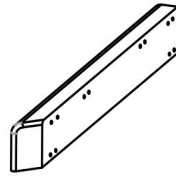

(C) x1

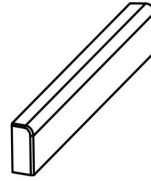

(D) x1

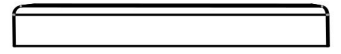

(E) x4

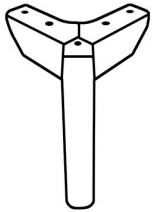

(F) x1

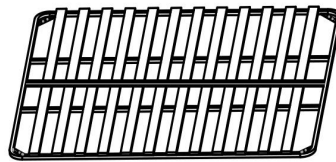

(G) x2

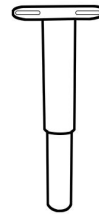

(H) x8

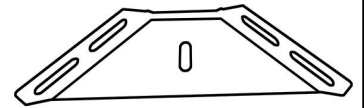

(I) x6

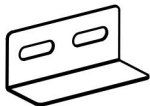

(J) x44



(K) x4



(L) x4



(M) x20

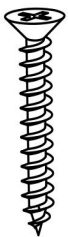

(N) x4

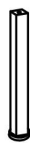

Step 1

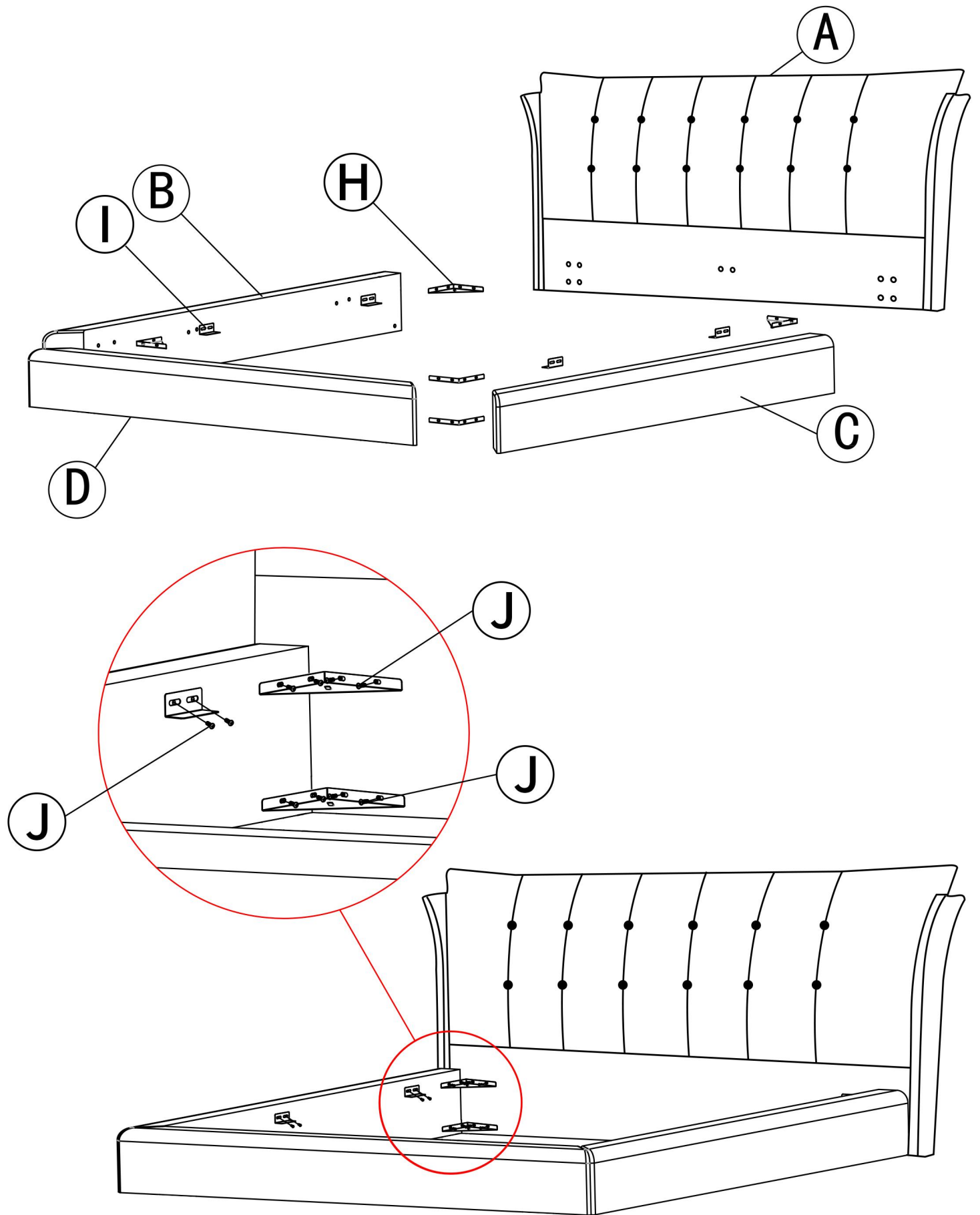

Step2

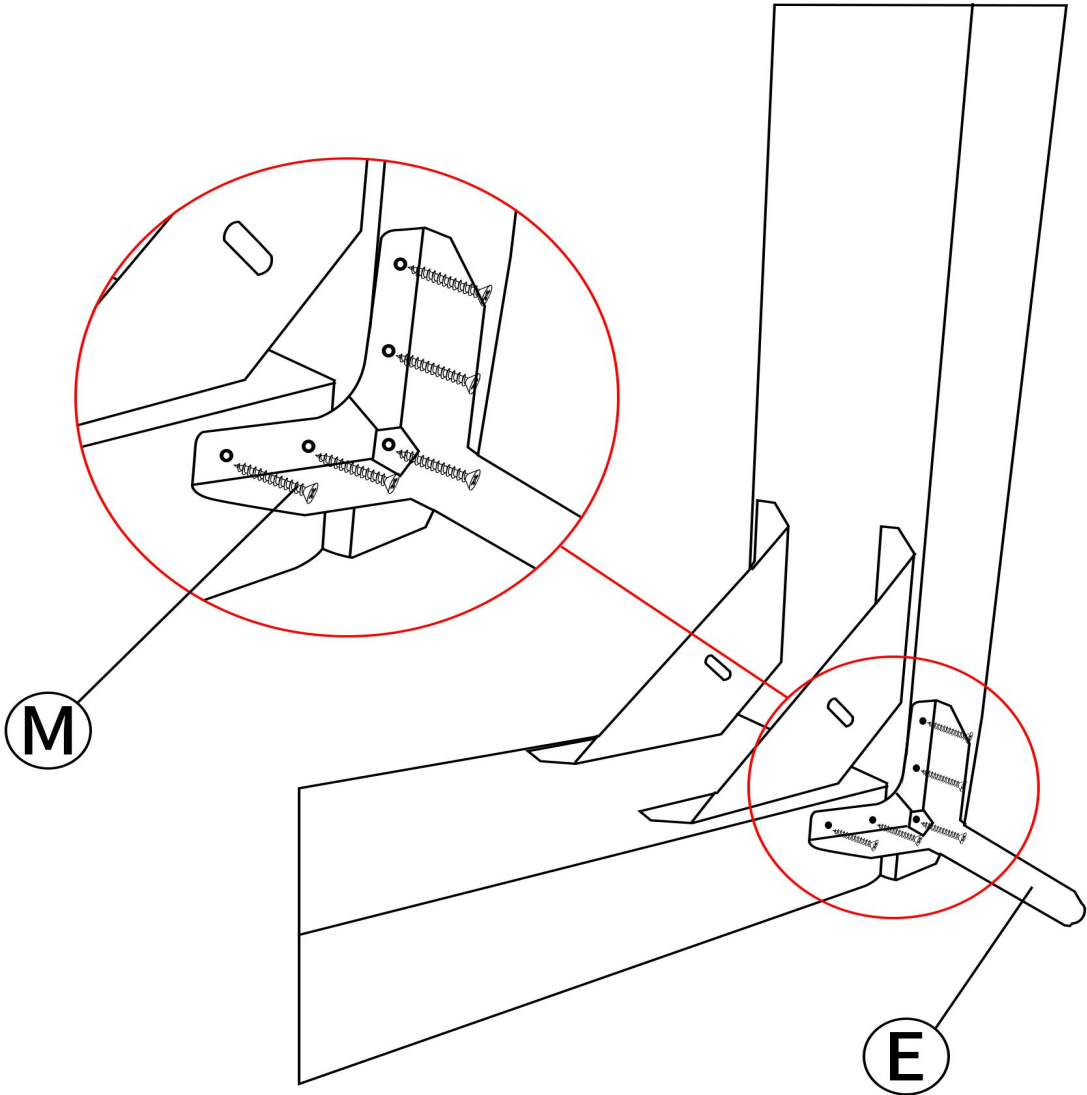

Step3

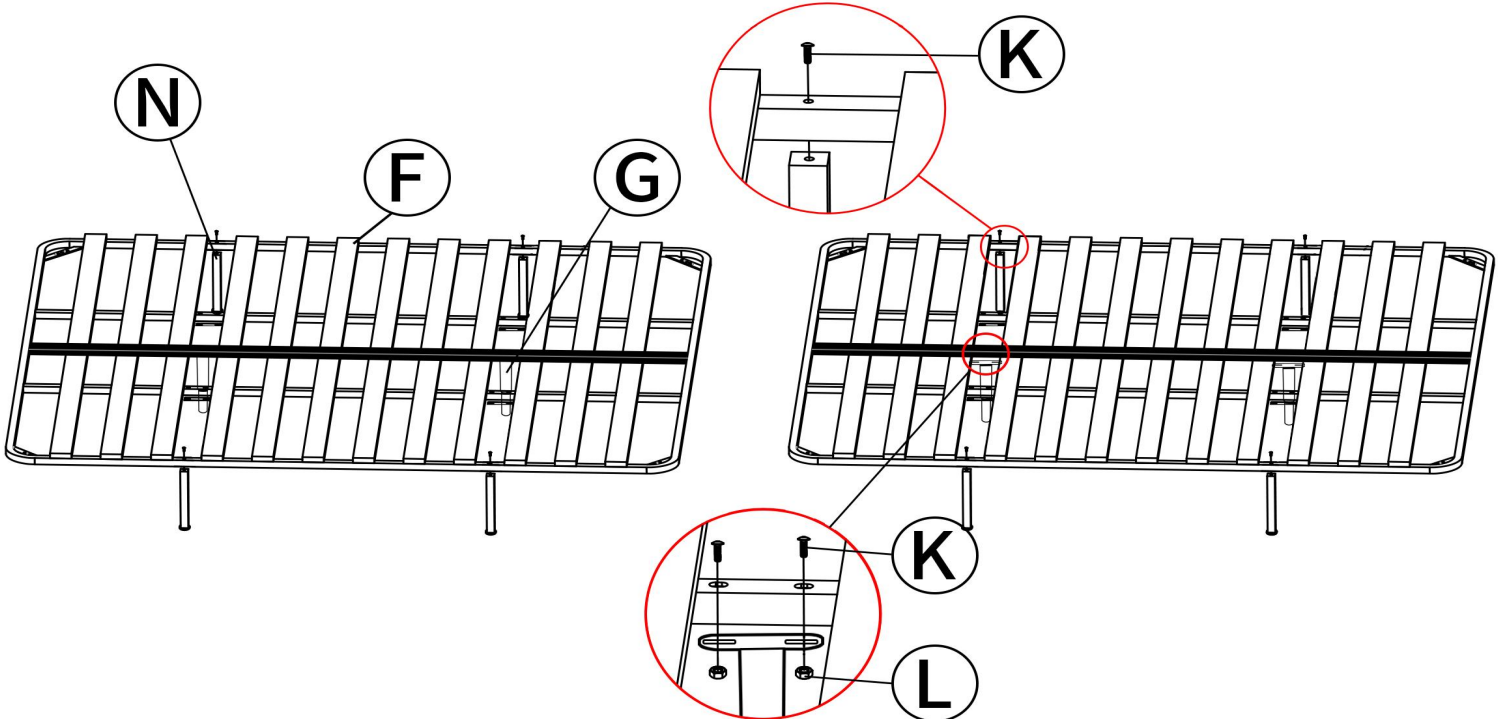

Step4

